

SITESYNC ANALOG STEEL DOUBLE-DIAL CLOCK INSTALLATION

INSTRUCTION SHEET: INST-DDA-SSIQ

REVISION: # 1

EFFECTIVE: 09-25-2024

IMPORTANT: If the double-dial ring has not already been mounted, refer to the instructions provided in the double-dial ring kit for mounting the ring, then return to these instructions to mount the clocks.

CONNECTING POWER

BATTERY-POWERED CLOCKS

1. Remove the locking pin from the movement.
2. Connect the barrel jack from the battery pack to the SiteSync receiver on both clocks as shown at right.

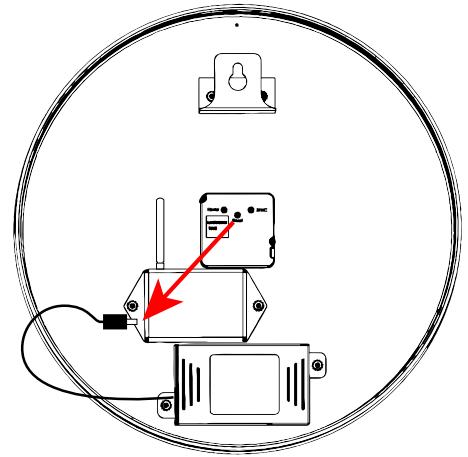

120VAC-POWERED CLOCKS

1. Remove the locking pin from the movement.
2. Plug the provided transformers into the two-prong cords from the mounting ring.
3. Connect the barrel jack from the transformer cords to the SiteSync receiver on both clocks.

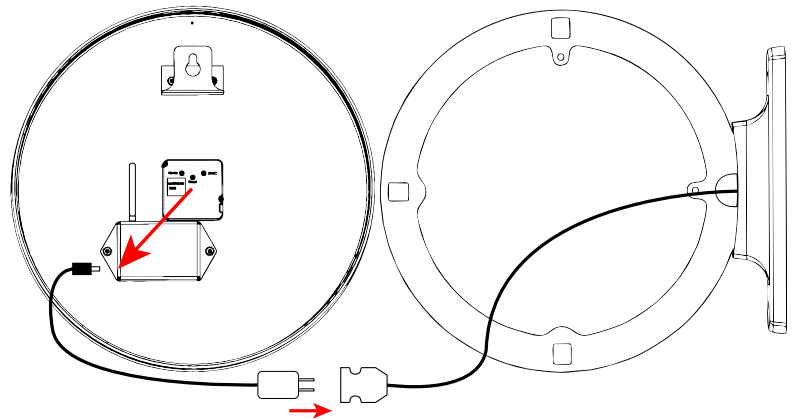

24VAC-POWERED CLOCKS

1. Remove the locking pin from the movement.
2. Connect the Molex wiring harnesses from the 24V adapters on the back of the clocks to the Molex plugs from the mounting ring, ensuring proper alignment of the wire connections (black to black, white to white).
3. Connect the barrel jack from the 24V adapter to the SiteSync receiver on both clocks (if disconnected).

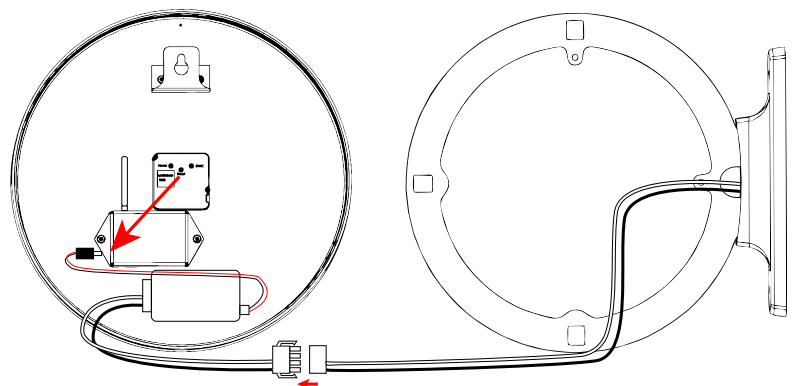

CLOCK INSTALLATION

1. Hang the clocks on the mounting ring by placing the metal hanger on the back of the clocks on the protruding screws on the mounting ring.
2. Tighten the three mounting clips on the mounting ring to secure the clocks in place.

WALL MOUNT

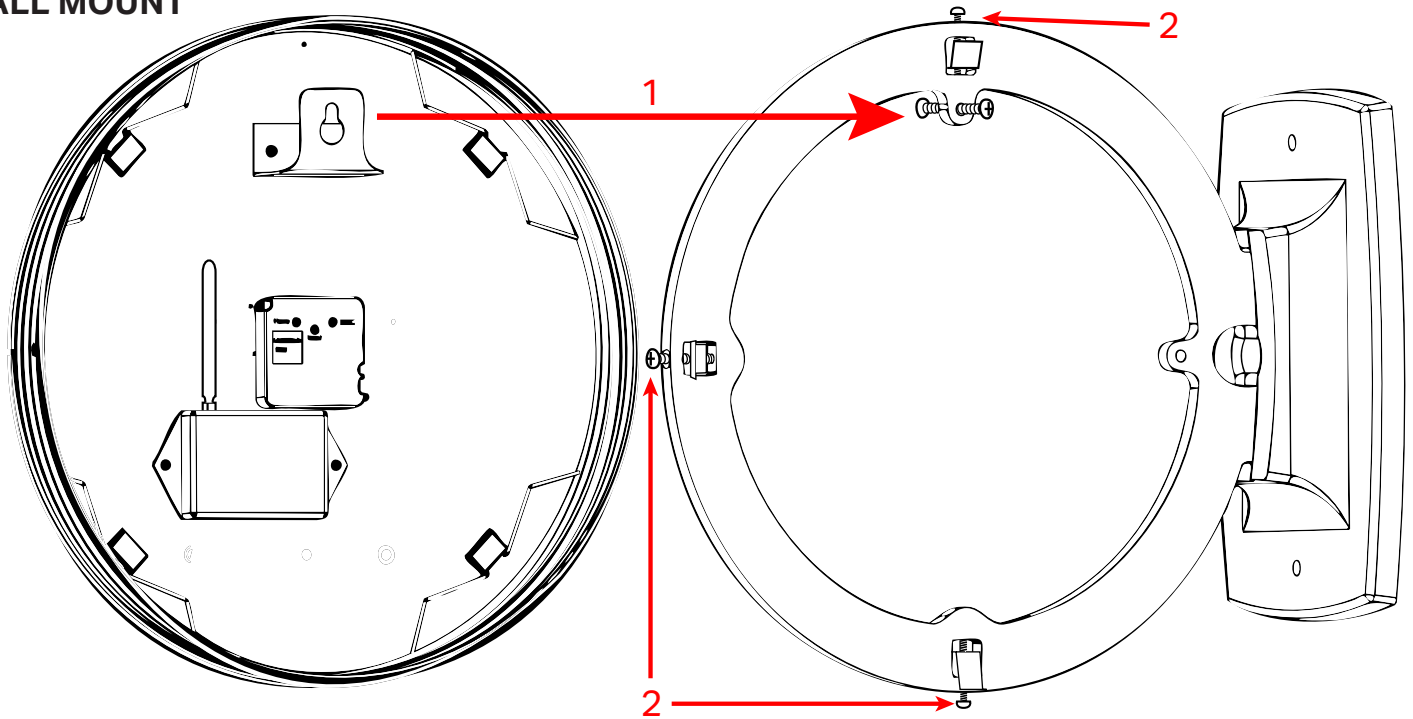

CEILING MOUNT

